

SMART Digital - DDA

Installation and operating instructions



Declaration of conformity

GB Declaration of Conformity

We, Grundfos Alldos, declare under our sole responsibility that the products DDA, DDC and DDE, to which this declaration relates, are in conformity with these Council directives on the approximation of the laws of the EC member states:

- Machinery Directive (2006/42/EC).
Standards used: EN 809: 1998, EN ISO 12100-1+A1: 2009,
EN ISO 12100-2+A1: 2009.
- Low Voltage Directive (2006/95/EC) *.
Standard used: EN 60204-1+A1: 2009.
- EMC Directive (2004/108/EC).
Standards used: EN 61000-6-2: 2005, EN 61000-6-4: 2007.

* Only for products with operating voltage > 50 VAC or >75 VDC.

Pfingztal, 1 November 2010

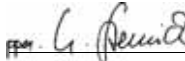

Ulrich Stemick
Technical Director
Grundfos Water Treatment GmbH
Reetzstr. 85, D-76327 Pfingztal, Germany

Person authorised to compile technical file and
empowered to sign the EC declaration of conformity.

Original installation and operating instructions.

CONTENTS

	Page		
1. Safety instructions	4	6.5	Analog output 26
1.1 Identification of safety instructions in these instructions	4	6.6	SlowMode 26
1.2 Qualification and training of personnel	4	6.7	FlowControl 27
1.3 Safety instructions for the operator/ user	4	6.8	Pressure monitoring 28
1.4 Safety of the system in the event of a failure in the dosing pump	4	6.8.1	Pressure setting ranges 28
1.5 Dosing chemicals	5	6.8.2	Calibration of pressure sensor 28
2. General	5	6.9	Flow measurement 29
2.1 Applications	5	6.10	AutoFlowAdapt 29
2.2 Improper operating methods	5	6.11	Auto deaeration 29
2.3 Warranty	6	6.12	Key lock 30
2.4 Nameplate	6	6.13	Display Setup 30
2.5 Type key	7	6.13.1	Units 30
2.6 Device overview	8	6.13.2	Additional display 30
3. Technical data / dimensions	9	6.14	Time/date 31
3.1 Technical data	9	6.15	Bus communication 31
3.2 Dimensions	11	6.16	Inputs/outputs 31
4. Assembly and installation	12	6.16.1	Relay outputs 31
4.1 Pump assembly	12	6.16.2	External stop 32
4.1.1 Requirements	12	6.16.3	Empty and low-level signals 32
4.1.2 Align and install mounting plate	12	6.17	Basic settings 32
4.1.3 Engage pump in mounting plate	12	7. Service	33
4.1.4 Adjusting control cube position	12	7.1	Service system 33
4.2 Hydraulic connection	13	7.2	Perform service 33
4.3 Electrical connection	14	7.2.1	Dosing head overview 34
5. Commissioning	16	7.2.2	Dismantling the diaphragm and valves 34
5.1 Setting the menu language	16	7.2.3	Reassembling the diaphragm and valves 34
5.2 Deaerating the pump	17	7.3	Resetting the service system 34
5.3 Calibrating the pump	17	7.4	Repairs 34
6. Operation	19	8. Faults	35
6.1 Control elements	19	8.1	List of faults 36
6.2 Display and symbols	19	8.1.1	Faults with error message 36
6.2.1 Navigation	19	8.1.2	General faults 38
6.2.2 Operating states	19	9. Disposal	38
6.2.3 Sleep mode (energy-saving mode)	19	<hr/>	
6.2.4 Overview of display symbols	20	<p style="text-align: center;">Warning</p> <p style="text-align: center;">Prior to installation, read these installation and operating instructions. Installation and operation must comply with local regulations and accepted codes of good practice.</p>	
6.3 Main menus	21		
6.3.1 Operation	21		
6.3.2 Info	21		
6.3.3 Alarm	21		
6.3.4 Setup	21		
6.4 Operation modes	22		
6.4.1 Manual	22		
6.4.2 Pulse	22		
6.4.3 Analog 0/4-20 mA	23		
6.4.4 Batch (pulse-based)	24		
6.4.5 Dosing timer, cycle	25		
6.4.6 Dosing timer, week	25		



Warning
Prior to installation, read these installation and operating instructions. Installation and operation must comply with local regulations and accepted codes of good practice.

1. Safety instructions

These installation and operating instructions contain general instructions that must be observed during installation, operation and maintenance of the pump. It must therefore be read by the installation engineer and the relevant qualified operator prior to installation and start-up, and must be available at the installation location at all times.

1.1 Identification of safety instructions in these instructions

The safety instructions are identified by the following symbols:



Warning

If these safety instructions are not observed, it may result in personal injury!

Caution

If these safety instructions are not observed, it may result in malfunction or damage to the equipment!

Note

Notes or instructions that make the job easier and ensure safe operation.

1.2 Qualification and training of personnel

The personnel responsible for the installation, operation and service must be appropriately qualified for these tasks. Areas of responsibility, levels of authority and the supervision of the personnel must be precisely defined by the operator. If necessary, the personnel must be trained appropriately.

Risks of not observing the safety instructions

Non-observance of the safety instructions may have dangerous consequences for the personnel, the environment and the pump and may result in the loss of any claims for damages.

It may lead to the following hazards:

- Personal injury from exposure to electrical, mechanical and chemical influences.
- Damage to the environment and personal injury from leakage of harmful substances.

1.3 Safety instructions for the operator/user

The safety instructions described in these instructions, existing national regulations on health protection, environmental protection and for accident prevention and any internal working, operating and safety regulations of the operator must be observed.

Information attached to the pump must be observed.

Leakages of dangerous substances must be disposed of in a way that is not harmful to the personnel or the environment.

Damage caused by electrical energy must be prevented, see the regulations of the local electricity supply company.

Caution

Before any work to the pump, the pump must be in the 'Stop' operational state or be disconnected from the mains. The system must be pressureless!

Only original accessories and original spare parts should be used. Using other parts can result in exemption from liability for any resulting consequences.

1.4 Safety of the system in the event of a failure in the dosing pump

The dosing pump was designed according to the latest technologies and is carefully manufactured and tested.

If it fails regardless of this, the safety of the overall system must be ensured. Use the relevant monitoring and control functions for this.

Caution

Make sure that any chemicals that are released from the pump or any damaged lines do not cause damage to system parts and buildings.

The installation of leak monitoring solutions and drip trays is recommended.

1.5 Dosing chemicals

Warning

Before switching the supply voltage back on, the dosing lines must be connected in such a way that any chemicals in the dosing head cannot spray out and put people at risk. The dosing medium is pressurised and can be harmful to health and the environment.



Warning

When working with chemicals, the accident prevention regulations applicable at the installation site should be applied (e. g. wearing protective clothing).



Observe the chemical manufacturer's safety data sheets and safety instructions when handling chemicals!

Warning

If the diaphragm leaks or is broken, dosing liquid will escape from the discharge opening on the dosing head (see fig. 3).



Take suitable precautions to prevent harm to health and damage to property from escaping dosing liquid!

Check daily whether liquid is escaping from the discharge opening!

Changing the diaphragm, see section 7. Service.

A deaeration hose, which is routed into a container, e. g. a drip tray, must be connected to the deaeration valve.

Caution

The dosing medium must be in liquid aggregate state!

Caution

Observe the freezing and boiling points of the dosing medium!

The resistance of the parts that come into contact with the dosing medium, such as the dosing head, valve ball, gaskets and lines, depends on the medium, media temperature and operating pressure.

Ensure that parts in contact with the dosing media are resistant to the dosing medium under operating conditions, see data booklet!

Caution

Should you have any questions regarding the material resistance and suitability of the pump for specific dosing media, please contact Grundfos.

2. General



The DDA dosing pump is a self-priming diaphragm pump. It consists of a housing with stepper motor and electronics, a dosing head with diaphragm and valves and the control cube.

Excellent dosing features of the pump:

- Optimal intake even with degassing media, as the pump always works at full suction stroke volume.
- Continuous dosing, as the medium is sucked up with a short suction stroke, regardless of the current dosing flow, and dosed with the longest possible dosing stroke.

2.1 Applications

The pump is suitable for liquid, non-abrasive, non-flammable and non-combustible media strictly in accordance with the instructions in these installation and operating instructions.

Areas of application

- Drinking water treatment
- Wastewater treatment
- Swimming pool water treatment
- Boiler water treatment
- CIP (Clean-In-Place)
- Cooling water treatment
- Process water treatment
- Wash plants
- Chemical industry
- Ultrafiltration processes and reverse osmosis
- Irrigation
- Paper and pulp industry
- Food and beverage industries

2.2 Improper operating methods

The operational safety of the pump is only guaranteed if it is used in accordance with section 2.1 Applications.

Warning

Other applications or the operation of pumps in ambient and operating conditions, which are not approved, are considered improper and are not permitted. Grundfos cannot be held liable for any damage resulting from incorrect use.



Warning

The pump is NOT approved for operation in potentially explosive areas!



Warning

A sunscreen is required for outdoor installation!



2.3 Warranty

A guarantee claim in accordance with our general terms of sale and delivery is only valid if the following requirements are fulfilled:

- The pump is used in accordance with the information within this manual.
- The pump is not dismantled or incorrectly handled.
- The maintenance is carried out by authorised and qualified personnel.
- Original spare parts are used for repairs during maintenance.

2.4 Nameplate

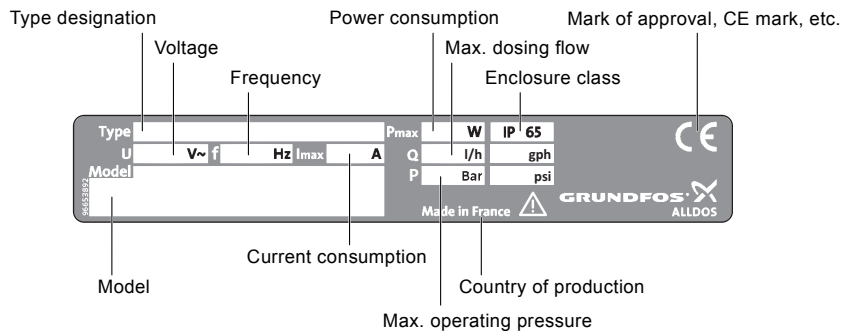

Fig. 1 Nameplate

2.5 Type key

The type key is used to identify the precise pump and is not used for configuration purposes.

Code	Example	DDA	7.5-	16	AR-	PP/	V/	C-	F-	3	1	U2U2	F	G
	Pump type													
	Max. flow [l/h]													
	Max. pressure [bar]													
	Control variant													
AR	Standard													
FC	AR with FlowControl													
FCM	FC with integrated flow measurement													
	Dosing head material													
PP	Polypropylene													
PVC	PVC (polyvinyl chloride) (PVC dosing heads only up to 10 bar)													
PV	PVDF (polyvinylidene fluoride)													
SS	Stainless steel DIN 1.4401													
PVC-P3	PVC with Plus ³													
	Gasket material													
E	EPDM													
V	FKM													
T	PTFE													
	Valve ball material													
C	Ceramic													
SS	Stainless steel DIN 1.4401													
	Control cube position													
F	Front-mounted (can be changed to the right or left)													
	Voltage													
3	1 x 100-240 V, 50/60 Hz													
	Valve type													
1	Standard													
2	Spring-loaded (HV version)													
	Suction/discharge side connection													
U2U2	Hose, 4/6 mm, 6/9 mm, 6/12 mm, 9/12 mm													
U7U7	Hose 1/8" x 1/4"; 0.17" x 1/4"; 1/4" x 3/8"; 3/8" x 1/2"													
AA	Threaded Rp 1/4", female (stainless steel)													
VV	Threaded 1/4" NPT, female (stainless steel)													
XX	No connection													
	Installation set*													
I001	Hose, 4/6 mm (up to 7.5 l/h, 16 bar)													
I002	Hose, 9/12 mm (up to 60 l/h, 13 bar)													
I003	Hose 0.17" x 1/4" (up to 7.5 l/h, 16 bar)													
I004	Hose, 3/8" x 1/2" (up to 60 l/h, 10 bar)													
	Power plug													
F	EU (Schuko)													
B	USA, Canada													
G	UK													
I	Australia, New Zealand, Taiwan													
E	Switzerland													
J	Japan													
L	Argentina													
	Design													
G	Grundfos Alldos													

*) including: 2 pump connections, foot valve, injection unit, 6 m PE discharge hose, 2 m PVC suction hose, 2 m PVC deaeration hose (4/6 mm)

2.6 Device overview

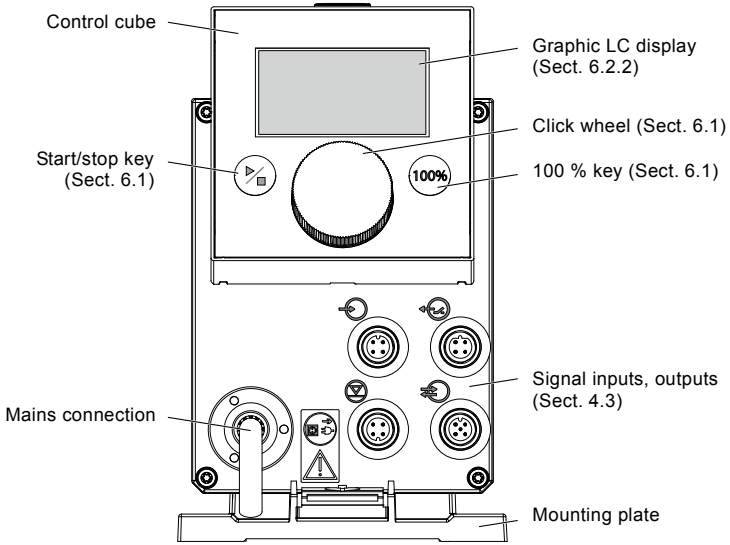

Fig. 2 Front view of the pump

TM04 1129 0110

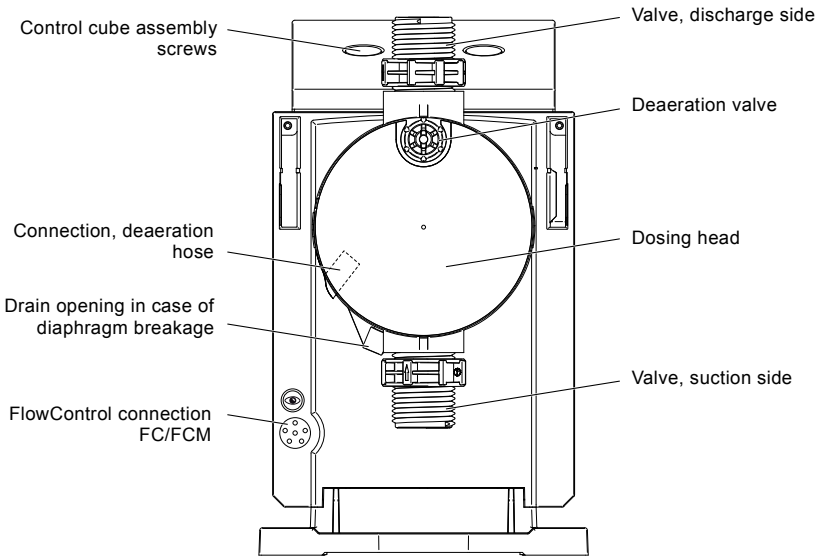

Fig. 3 Rear view of the pump

TM04 1133 0110

3. Technical data / dimensions



3.1 Technical data

Data		DDA pump type			
		7.5 - 16	12-10	17-7	30-4
Turndown ration (setting range)	[1:X]	3000	1000	1000	1000
	[l/h]	7.5	12.0	17.0	30.0
Max. dosing flow	[gph]	2.0	3.1	4.5	8.0
	[l/h]	3.75	6.00	8.50	15.00
Max. dosing flow with SlowMode 50 %	[gph]	1.00	1.55	2.25	4.00
	[l/h]	1.88	3.00	4.25	7.50
Max. dosing flow with SlowMode 25 %	[gph]	0.50	0.78	1.13	2.00
	[l/h]	0.0025	0.0120	0.0170	0.0300
Min. dosing flow	[gph]	0.0007	0.0031	0.0045	0.0080
	[bar]	16	10	7	4
Max. operating pressure	[psij]	230	150	100	60
	[Strokes/min]	190	155	205	180
Max. stroke frequency ¹⁾	[ml]	0.74	1.45	1.55	3.10
Stroke volume	[m]	±1			
Accuracy of repeatability	[m]	6			
Max. suction lift during operation ²⁾	[m]	2	3	3	2
Max. suction lift when priming with wet valves ²⁾	[bar]	1 (FC and FCM: 2)			
Min. pressure difference between suction and discharge side	[bar]	2			
Max. pressure, suction side	[mPa s] (= cP)	2500	2500	2000	1500
Max. viscosity in SlowMode 25 % with spring-loaded valves ³⁾	[mPa s] (= cP)	1800	1300	1300	600
Max. viscosity in SlowMode 50 % with spring-loaded valves ³⁾	[mPa s] (= cP)	600	500	500	200
Max. viscosity without SlowMode with spring-loaded valves ³⁾	[mPa s] (= cP)	50	300	300	150
Max. viscosity without spring-loaded valves ³⁾	[mm]	4	6	6	9
Min. diameter of hose/pipe on suction/discharge side ^{2) 4)}	[mm]	9			
Min. diameter of hose/pipe on suction side for highly viscous media (HV) ⁴⁾	[mm]	9			
Min. diameter of hose/pipe on discharge side for highly viscous media (HV) ⁴⁾	[°C]	45			
Max. media temperature	[°C]	-10			
Min. media temperature	[°C]	45			
Max. ambient temperature	[°C]	0			
Min. ambient temperature	[°C]	70			
Max. storage temperature	[°C]	-20			
Min. storage temperature					

Data		DDA pump type			
		7.5 - 16	12-10	17-7	30-4
Electrical data	Voltage [V]	100-240 V, 50-60 Hz			
	Length of mains cable [m]	1.5			
	Max. current consumption (100 V) [A]	8			
	Max. current consumption (230 V) [A]	25			
	Max. power consumption P ₁ [W]	18 / 24 ⁵⁾			
	Enclosure class	IP 65, Nema 4X			
	Electrical safety class	II			
Signal input	Max. load for level input	12 V, 5 mA			
	Max. load for pulse input	12 V, 5 mA			
	Max. load for external stop	12 V, 5 mA			
	Min. pulse length [ms]	5			
	Max. pulse frequency [Hz]	100			
	Impedance at 0/4-20 mA analog input [Ω]	15			
	Max. resistance in level circuit [Ω]	1000			
Max. resistance in pulse circuit [Ω]	1000				
Signal output	Max. ohmic load on relay output [A]	0.5			
	Max. voltage on relay output [V]	30 VDC / 30 VAC			
	Impedance at 0/4-20 mA analog output [Ω]	500			
Weight/ size	Weight (PVC, PP, PVDF) [kg]	2.4	2.4	2.6	
	Weight (stainless steel) [kg]	3.2	3.2	4.0	
	Diaphragm diameter [mm]	44	50	74	
Sound pressure level	Max. sound pressure level [dB(A)]	60			
Approvals		CE, CSA-US, NSF61, GHOST, C-Tick			

1) The maximum stroke frequency varies depending on calibration

2) Data is based on measurements with water

3) Maximum suction lift: 1 m, dosing flow reduced (approx. 30 %)

4) Length of suction line: 1.5 m / length of discharge line: 10 m (at max. viscosity)

5) With E-Box.

3.2 Dimensions

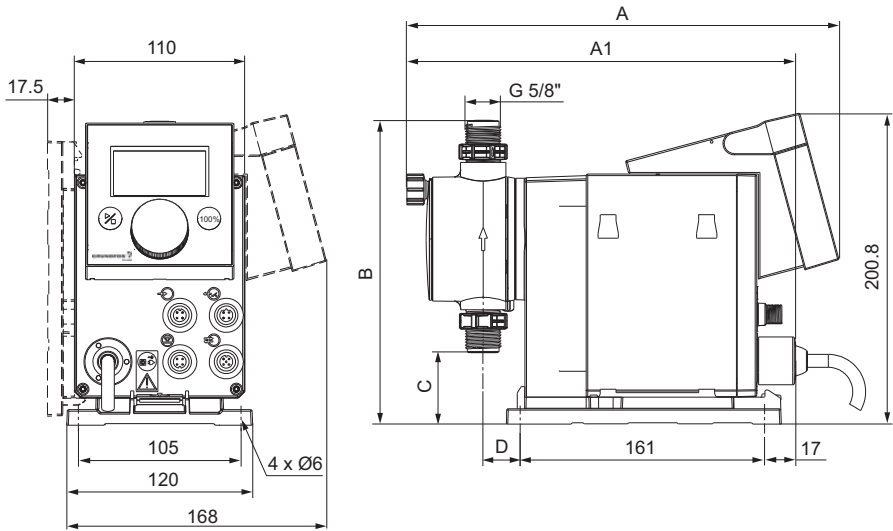

TM04 1103 0110

Fig. 4 Dimensional drawing

Pump type	A [mm]	A1 [mm]	B [mm]	C [mm]	D [mm]
DDA 7.5 - 16	280	251	196	46.5	24
DDA 12-10/17-7	280	251	200.5	39.5	24
DDA 30-4	295	267	204.5	35.5	38.5

4. Assembly and installation



4.1 Pump assembly

The pump is delivered with a mounting plate. The mounting plate can be mounted vertically e. g. on a wall or horizontally e. g. on a tank. It takes just a few quick steps to firmly secure the pump to the mounting plate by means of a slot mechanism. The pump can easily be released from the mounting plate for maintenance.

4.1.1 Requirements

- The mounting surface must be stable and must not vibrate.
- Dosing must flow upwards vertically.

4.1.2 Align and install mounting plate

- **Vertical installation:** Mounting plate slot mechanism must be above.
- **Horizontal installation:** Mounting plate slot mechanism must be opposite the dosing head.
- The mounting plate can be used as a drill template, please see fig. 4 for drill hole distances.

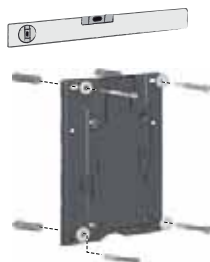

Fig. 5 Locate mounting plate



Warning

Make sure that you do not damage any cables and lines during installation!

1. Indicate drill holes.
2. Drill holes.
3. Secure mounting plate using four screws, diameter 5 mm, to the wall, on the bracket or the tank.

4.1.3 Engage pump in mounting plate

1. Attach the pump to the mounting plate support clamps and slide under slight pressure until it engages.

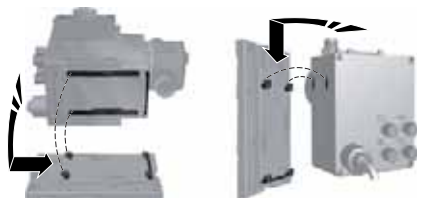

Fig. 6 Engaging the pump

4.1.4 Adjusting control cube position

The control cube is fitted to the front of the pump on delivery. It can be turned by 90 ° so that the user can select to operate the pump from the right or left side.

The enclosure class (IP65 / Nema 4X) and shock protection are only guaranteed if the control cube is installed correctly!

Caution

Caution Pump must be disconnected from the power supply!

1. Carefully remove both protective caps on the control cube using a thin screwdriver.
2. Loosen screws.
3. Carefully lift off control cube only so far from the pump housing that no tensile stress is produced on the flat band cable.
4. Turn control cube by 90 ° and re-attach.
 - Make sure the O-ring is secure.
5. Tighten screws slightly and attach protective caps.



Fig. 7 Adjusting control cube

4.2 Hydraulic connection



Warning

Risk of chemical burns!

Wear protective clothing (gloves and goggles) when working on the dosing head, connections or lines!

The dosing head may contain water from the factory check!

Caution

When dosing media which should not come into contact with water, another medium must be dosed beforehand!

Caution

Faultless function can only be guaranteed in conjunction with lines supplied by Grundfos!

Caution

The lines used must comply with the pressure limits as per section 3.1 Technical data!

Important information on installation

- Observe suction lift and line diameter, see section 3.1 *Technical data*.
- Shorten hoses at right angles.
- Ensure that there are no loops or kinks in the hoses.
- Keep suction line as short as possible.
- Route suction line up towards the suction valve.
- Installing a filter in the suction line protects the entire installation against dirt and reduces the risk of leakage.
- *Only control variant FC/FCM:* For discharge quantities < 1 l/h we recommend the use of an additional spring-loaded valve (approx. 3 bar) on the discharge side for the safe generation of the necessary differential pressure.

Hose connection procedure

1. Push union nut and tensioning ring across hose.
2. Push cone part fully into hose, see fig. 8.
3. Attach cone part with hose to corresponding pump valve.
4. Tighten union nut manually.
– do not use tools!
5. Tighten up union nuts after 2-5 operating hours if using PTFE gaskets!
6. Attach deaeration hose to the corresponding connection (see fig. 3) and run into a container or a collecting tray.

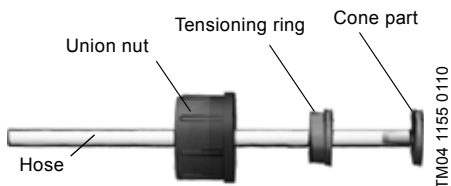

Fig. 8 Hydraulic connection

Note

Pressure differential between suction and discharge side must be at least 1 bar / 14.5 psi!

Caution

Tighten up the dosing head screws once before commissioning and after 2-5 operating hours at 3 Nm.

Installation example

The pump offers various installation options. In the picture below, the pump is installed in conjunction with a suction line, level switch and multifunction valve on a Grundfos tank.

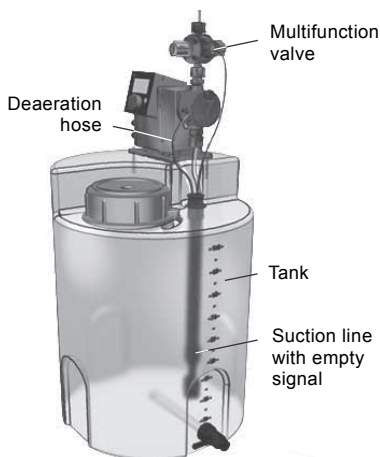

Fig. 9 Installation example

4.3 Electrical connection



Warning

The enclosure class (IP65 / Nema 4X) is only guaranteed if plugs or protective caps are correctly installed!



Warning

The pump can start automatically when the mains voltage is switched on!
Do not manipulate mains plug or cable!

The rated voltage of the pump, see section 2.4 Nameplate, must conform to local conditions.

Signal connections

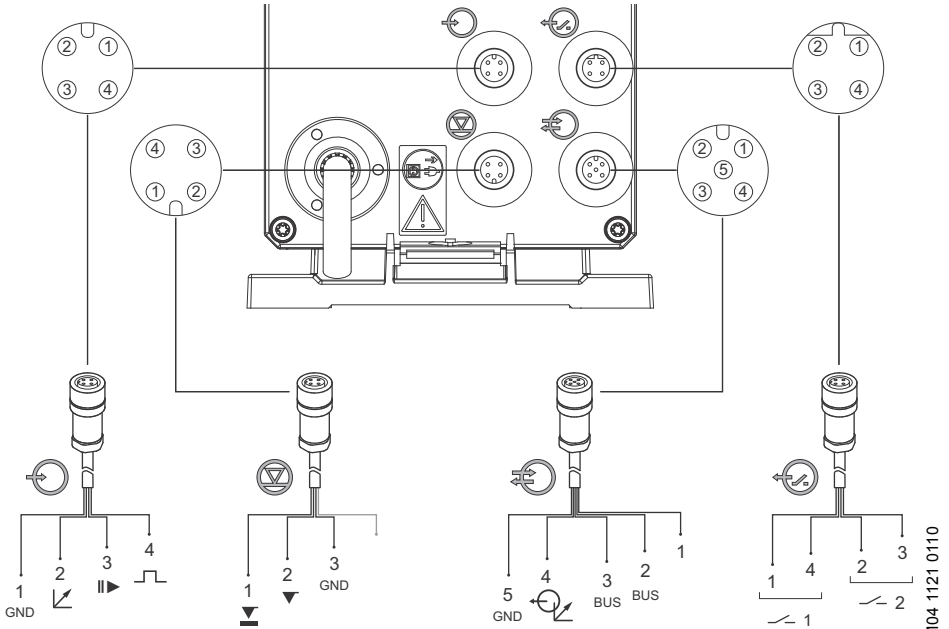

TM04 1121 0110

Fig. 10 Wiring diagram of the electrical connections

Analog, external stop and pulse input

Function	Pins				Plug type
	1/brown	2/white	3/blue	4/black	
Analog	GND/ (-) mA	(+) mA			mA signal
External stop	GND		X		Pulse
Pulse	GND			X	Pulse

Level signals: empty and low-level signal

Function	Pins				Plug type
	1/brown	2/white	3/blue	4/black	
Low-level signal	X		GND		Pulse
Empty signal		X	GND		Pulse

GENIbus, analog output

Function	Pins					Plug type
	1/brown	2/white	3/blue	4/black	5/yellow/green	
GENIbus	+30 V	GENI bus TXD	GENI bus RXD		GND	Bus
Analog output				(+) mA	GND/ (-) mA	mA signal

Relay outputs

Function	Pins				Plug type
	1/brown	2/white	3/blue	4/black	
Relay 1	X			X	Pulse
Relay 2		X	X		Pulse

FlowControl signal connection

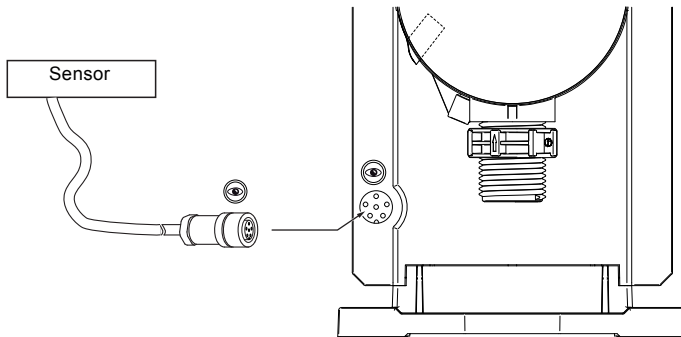

Fig. 11 FlowControl connection

TM04 1158 0110

5. Commissioning

5.1 Setting the menu language

For description of control elements, see Section 6.

1. Turn click wheel to highlight the cog symbol.
2. Press the click wheel to open the 'Setup' menu.
3. Turn the click wheel to highlight the 'Language' menu.
4. Press the click wheel to open the 'Language' menu.
5. Turn the click wheel to highlight the desired language.
6. Press the click wheel to select the highlighted language.
7. Press the click wheel again to confirm the 'Confirm settings' prompt and apply the setting.

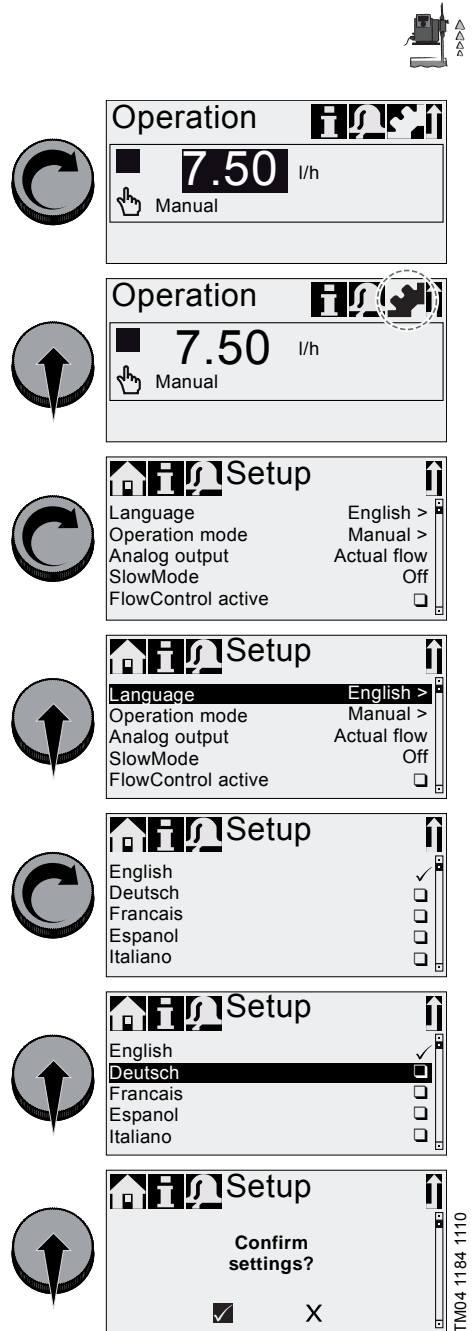

Fig. 12 Set menu language

5.2 Deaerating the pump



Warning

The deaeration hose must be connected correctly and inserted into a suitable tank!

1. Open deaeration screw by approximately half a turn.
2. Press and hold down the 100 % key (deaeration key) until liquid flows continuously without any bubbles from the deaeration hose.
3. Close deaeration screw.

Press the 100 % key and simultaneously turn the clickwheel clockwise to increase the duration of the process to up to 300 seconds. After setting the seconds, do not press the key any longer.

Note

5.3 Calibrating the pump

The pump is calibrated in the factory for media with a viscosity similar to water at maximum pump backpressure (see section 3.1 *Technical data*).

If the pump is operated with a backpressure that deviates or if dosing a medium whose viscosity deviates, the pump must be calibrated.

For pumps with FCM control variant, it is not necessary to calibrate the pump if there is deviating or fluctuating backpressure as long as the 'AutoFlowAdapt' function has been enabled (see section 6.10 *AutoFlowAdapt*).

Requirements

- The hydraulics and electrics of the pump are connected (see section 4. *Assembly and installation*).
- The pump is integrated into the dosing process under operating conditions.
- The dosing head and suction hose are filled with dosing medium.
- The pump has been deaerated.

Calibration process - example for DDA 7.5 - 16

1. Fill a measuring beaker with dosing medium.
Recommended filling volumes:

DDA type	7.5 - 16	12-10	17-7	30-4
Medium V_1	0.3 l	0.5 l	1.0 l	1.5 l

2. Read off and note down the fill volume V_1 (e. g. 300 ml).
3. Place the suction hose in the measuring beaker.

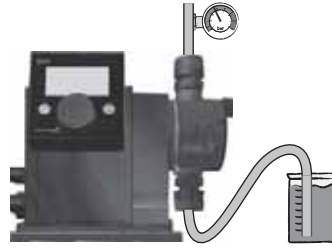
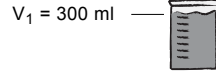

4. Start the calibration process in the 'Setup > Calibration' menu.

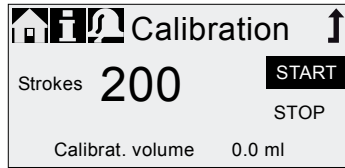

5. The pump executes 200 dosing strokes and displays the factory calibration value (e. g. 125 ml).



6. Remove the suction hose from the measuring beaker and check the remaining volume V_2 (e. g. 170 ml).

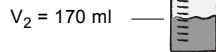

7. From V_1 and V_2 , calculate the actual dosed volume $V_d = V_1 - V_2$ (e. g. 300 ml - 170 ml = 130 ml).

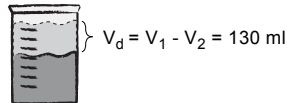

8. Set and apply V_d in the calibration menu.
– The pump is calibrated.

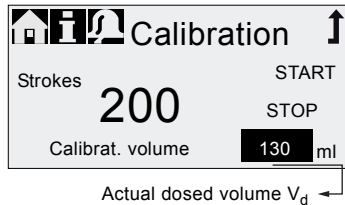

6. Operation



6.1 Control elements

The pump control panel includes a display and the following control elements.

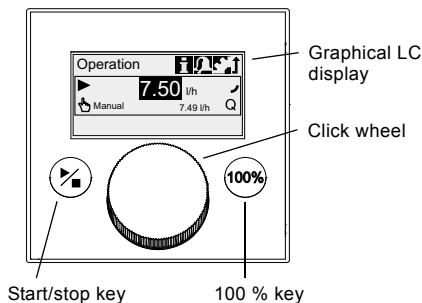

Fig. 13 Control panel

Keys

Key	Function
Start/stop key	Starting and stopping the pump.
100 % key	The pump doses at maximum flow regardless of the operation mode.

Click wheel

The click wheel is used to navigate through the menus, select settings and confirm them.

Turning the clickwheel clockwise moves the cursor clockwise in increments in the display. Turning the clickwheel anti-clockwise moves the cursor anti-clockwise.

6.2 Display and symbols

6.2.1 Navigation

In the 'Info', 'Alarm' and 'Setup' main menus, the options and submenus are displayed in the rows below. Use the 'Back' symbol to return to the higher menu level. The scroll bar at the right edge of the display indicates that there are further menu items which are not shown.

The active symbol (current cursor position) flashes. Press the click wheel to confirm your selection and open the next menu level. The active main menu is displayed as text, the other main menus are displayed as symbols. The position of the cursor is highlighted in black in the sub-menu.

When you position the cursor on a value and press the click wheel, a value is selected. Turning the clickwheel clockwise increases the value, turning the clickwheel anti-clockwise reduces the value. When you now press the click wheel, the cursor will be released again.

6.2.2 Operating states

The operating state of the pump is indicated by a symbol and display colour.

Display	Fault	Operating state		
White	-	Stop ■	Standby 	
Green	-			Running ▶
Yellow	Warning	Stop ■	Standby 	Running ▶
Red	Alarm	Stop ■	Standby 	

6.2.3 Sleep mode (energy-saving mode)

If in the 'Operation' main menu the pump is not operated for 30 seconds, the header disappears. After 2 minutes, the display switches to the 'Operation' main menu and the display brightness is reduced. This state will be cancelled when the pump is operated or a fault occurs.

TM04 1104 1120

6.2.4 Overview of display symbols

The following display symbols may appear in the menus.

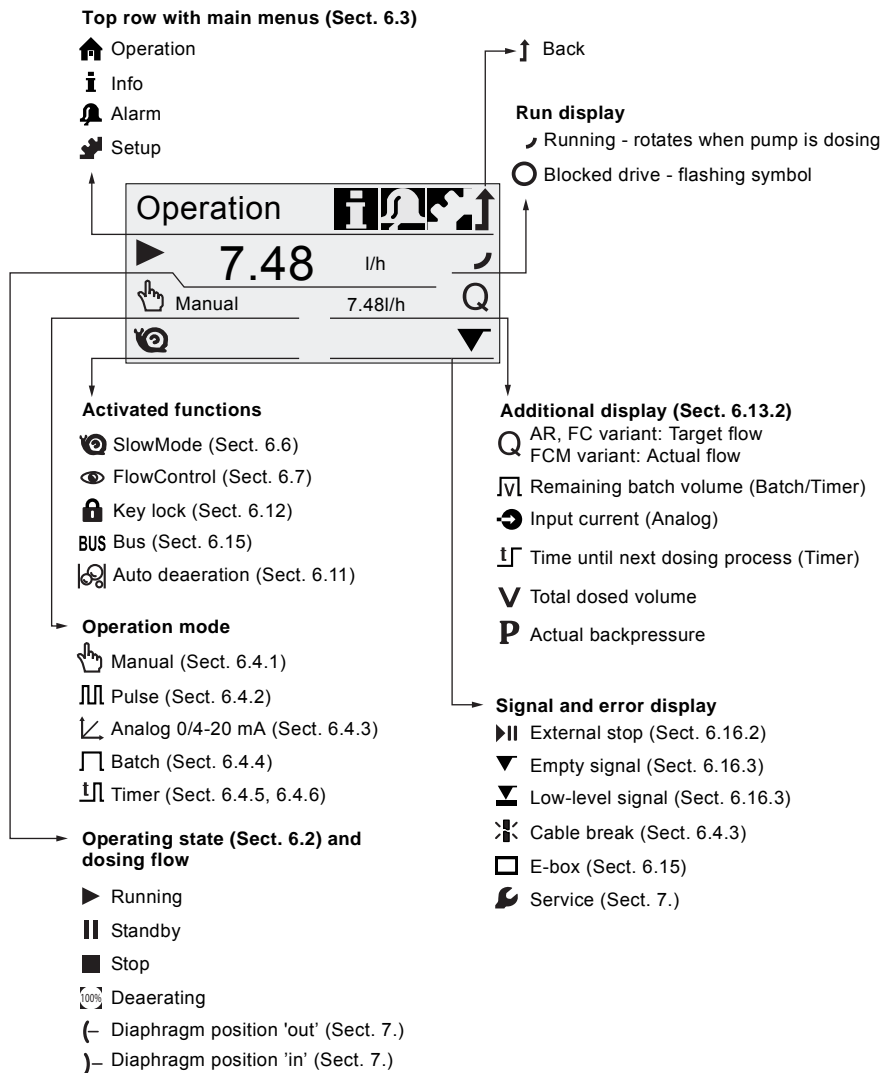

Fig. 14 Overview of display symbols

6.3 Main menus

The main menus are displayed as symbols at the top of the display. The currently active main menu is displayed as text.

6.3.1 Operation

Status information such as the dosing flow, selected operation mode and operating state is displayed in the 'Operation' main menu.

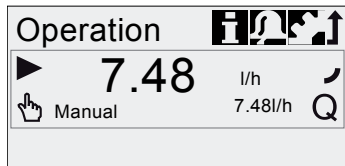

TM04 1157 1010

6.3.2 Info

You can find the date, time and information about the active dosing process, various counters, product data and the service system status in the 'Info' main menu. The information can be accessed during operation.

The service system can also be reset from here.

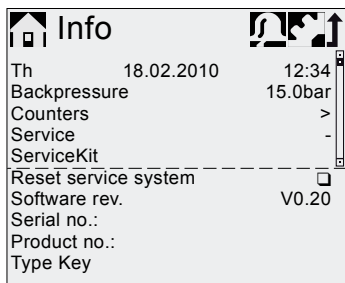

TM04 1106 1010

Counters

The 'Info > counters' menu contains the following counters:

Counters	resettable
Volume	
Total dosed volume [l] or US gallons	Yes
Operating hours	
Accumulated operating hours (pump switched on) [h]	No
Motor runtime	
Accumulated motor runtime [h]	No
Strokes	
Accumulated number of dosing strokes	No
Power on/off	
Accumulated frequency of switching mains voltage on	No

6.3.3 Alarm

You can view errors in the 'Alarm' main menu.

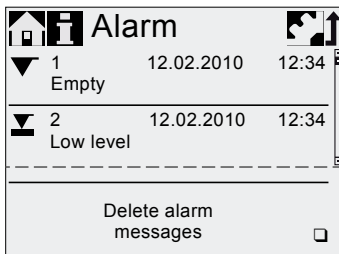

TM04 1109 1010

Up to 10 warnings and alarms, together with their date, time and cause, are listed in chronological order. If the list is full, the oldest entry will be overwritten, see Section 8. *Faults*.

6.3.4 Setup

The 'Setup' main menu contains menus for pump configuration. These menus are described in the following sections.

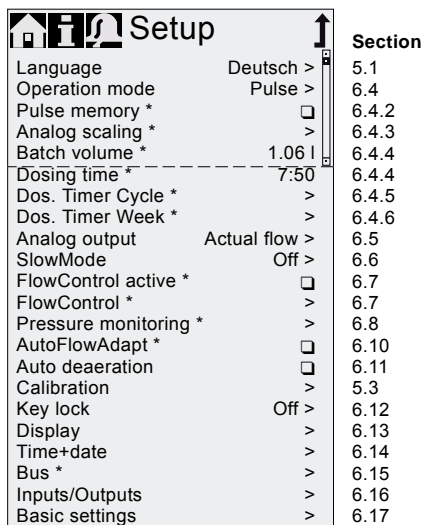

TM04 1110 1010

* These submenus are only displayed for specific default settings and control variants. The contents of the 'Setup' menu also vary depending on the operation mode.

6.4 Operation modes

Six different operation modes can be set in the 'Setup > Operation mode' menu.

- **Manual**, see section 6.4.1
- **Pulse**, see section 6.4.2
- **Analog 0 - 20 mA**, see section 6.4.3
- **Analog 4 - 20 mA**, see section 6.4.3
- **Batch**, see section 6.4.4
- **Dosing timer, cycle**, see section 6.4.5
- **Dosing timer, week**, see section 6.4.6

6.4.1 Manual

In this operation mode, the pump constantly doses the dosing flow set with the click wheel. The dosing flow is set in l/h or ml/h. The pump automatically switches between the units. Alternatively, the display can be reset to US units (gph).

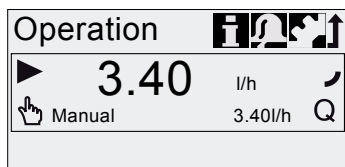

Fig. 15 Manual mode

The setting range depends on the pump type:

Type	Setting range*	
	l/h	gph
DDA 7.5 - 16	0.0025 - 7.5	0.0007 - 2.0
DDA 12-10	0.012 - 12	0.0031 - 3.1
DDA 17-7	0.017 - 17	0.0045 - 4.5
DDA 30-4	0.03 - 30	0.0080 - 8.0

* When the SlowMode function is active, the maximum dosing flow is reduced, see section 3.1 *Technical data*.

6.4.2 Pulse

In this operation mode, the pump doses the set dosing volume for each incoming (potential-free) pulse, e. g. from a water meter. There is no direct connection between incoming pulses and dosing strokes. The pump automatically calculates the optimum stroke frequency for dosing the set volume per pulse.

The calculation is based on:

- the frequency of external pulses
- the set dosing volume/pulse.

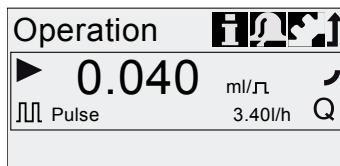

Fig. 16 Pulse operation mode

The dosing volume per pulse is set in ml/pulse using the click wheel. The setting range for the dosing volume depends on the pump type:

Type	Setting range [ml/pulse]
DDA 7.5 - 16	0.0013 - 12.8
DDA 12-10	0.0026 - 25.8
DDA 17-7	0.0027 - 26.8
DDA 30-4	0.0058 - 58.4

The frequency of incoming pulses is multiplied by the set dosing volume. If the pump receives more pulses than it can process at the maximum dosing flow, it runs at the maximum stroke frequency in continuous operation. Excess pulses will be ignored if the memory function is not enabled.

Memory function

When the 'Setup > Pulse memory' function is enabled, up to 65,000 unprocessed pulses can be saved for subsequent processing.

The contents of the memory will be deleted when:

- Switching off the power supply
- By switching the operating mode
- Interruption (e. g. alarm, external stop).

Note

6.4.3 Analog 0/4-20 mA

In this operation mode, the pump doses according to the external analog signal. The dosing volume is proportional to the signal input value in mA.

Operation mode	Input value	Dosing flow
4 - 20 mA	≤ 4.1 mA	0 %
	≥ 19.8 mA	100 %
0 - 20 mA	≤ 0.1 mA	0 %
	≥ 19.8 mA	100 %

If the input value in operation mode 4-20 mA falls below 2 mA, an alarm is displayed and the pump stops. A cable break or signal transmitter error has occurred. The 'Cable break' symbol is displayed in the 'Signal and error display' area of the display.

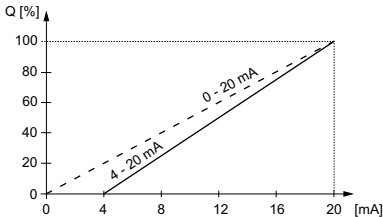

Fig. 17 Analog scaling

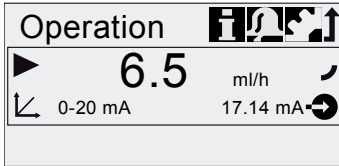

Fig. 18 Analog operation mode

Set analog scaling

Analog scaling refers to the assignment of the current input value to the dosing flow.

Analog scaling passes through the two reference points (I_1 / Q_1) and (I_2 / Q_2), which are set in the 'Setup > Analog scaling' menu. The dosing flow is controlled according to this setting.

Example 1 (DDA 7.5 - 16)

Analog scaling with positive gradient:

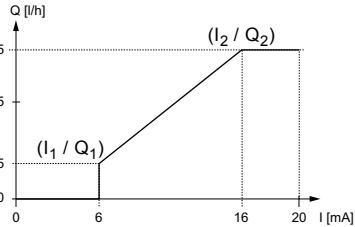

Fig. 19 Analog scaling with pos. gradient

In example 1, the reference points $I_1 = 6$ mA, $Q_1 = 1.5$ l/h and $I_2 = 16$ mA, $Q_2 = 7.5$ l/h have been set.

From 0 to 6 mA analog scaling is described by a line that passes through $Q = 0$ l/h, between 6 mA and 16 mA it rises proportionally from 1.5 l/h to 7.5 l/h and from 16 mA onwards it passes through $Q = 7.5$ l/h.

Example 2 (DDA 7.5-16)

Analog scaling with negative gradient (Operation mode 0 - 20 mA):

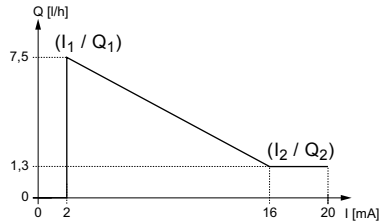

Fig. 20 Analog scaling with neg. gradient

In example 2, the reference points $I_1 = 2$ mA, $Q_1 = 7.5$ l/h and $I_2 = 16$ mA, $Q_2 = 1.3$ l/h have been set.

From 0 to 2 mA analog scaling is described by a line that passes through $Q = 0$ l/h, between 2 mA and 16 mA it drops proportionally from 7.5 l/h to 1.3 l/h and from 16 mA onwards it passes through $Q_2 = 1.3$ l/h.

Set analog scaling in the 'Operation' menu

Analog scaling can also be modified after a security prompt directly in the 'Operation' menu. This is how the dosing flow is directly modified for the current flow input value.

Caution Please observe that changes also have a direct effect on point I_2 / Q_2 (see fig. 21)!

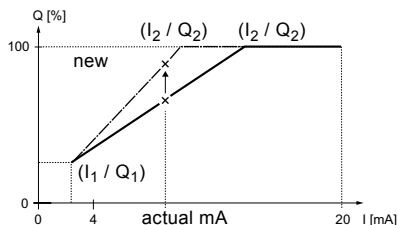

Fig. 21 Set analog scaling ('Operation' menu)

6.4.4 Batch (pulse-based)

In this operation mode, the pump doses the set batch volume in the set dosing time (t_1). A batch is dosed with each incoming pulse.

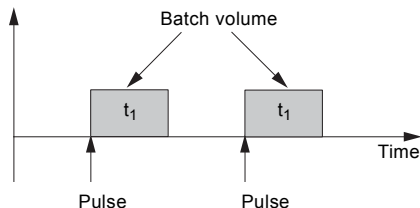

Fig. 22 Batch (pulse-based)

The setting range depends on the pump type:

Type	Setting range per batch		Resolution* [ml]
	from [ml]	to [l]	
DDA 7.5 - 16	0.74	999	0.0925
DDA 12-10	1.45	999	0.1813
DDA 17-7	1.55	999	0.1938
DDA 30-4	3.10	999	0.3875

* Thanks to the digital motor control, dosing quantities with a resolution of up to 1/8 of the dosing stroke volume can be dosed.

The batch volume (e. g. 75 ml) is set in the 'Setup > Batch volume' menu. The minimum dosing time required for this (e. g. 32 seconds) is displayed and can be increased.

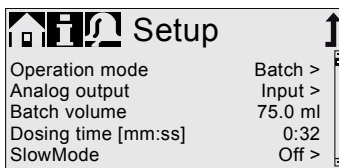

Fig. 23 Batch mode

If the batch volume is modified, the dosing time resets to the minimum dosing time. Signals received during a batch process or an interruption (e. g. alarm, external stop) will be ignored. If the pump is restarted following an interruption, the next batch volume is dosed on the next incoming pulse.

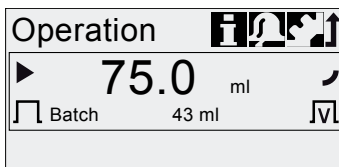

Fig. 24 Batch mode

In the 'Operation' menu, the total batch volume (e. g. 75 ml) and the remaining batch volume still to be dosed (e. g. 43 ml) are shown in the display.

6.4.5 Dosing timer, cycle

In this operation mode, the pump doses the set batch volume in regular cycles. Dosing starts when the pump is started after a singular start delay. The setting range for the batch volume corresponds to the values in section 6.4.4 *Batch (pulse-based)*.

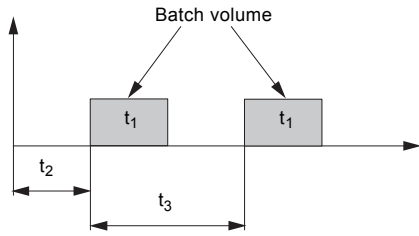

Fig. 25 Dosing timer cycle

t_1	Dosing time
t_2	Start delay
t_3	Cycle time

The cycle time must be longer than the dosing time, otherwise the following dosing will be ignored. In the event of an interruption (e. g. interruption of the mains voltage, external stop), the dosing will be stopped while the time continues running. After suspending the interruption, the pump will continue to dose according to the actual timeline position.

The following settings are required in the 'Setup > Dos. Timer Cycle' menu:

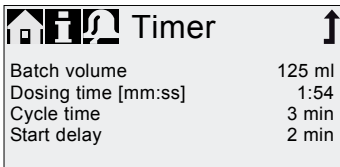

Fig. 26 Dos. Timer Cycle mode

The batch volume to be dosed (e. g. 125 ml) is set in the 'Setup > Dos. Timer Cycle' menu. The minimum dosing time required for this (e. g. 1:54) is displayed and can be increased.



TM04 1107 1109

TM04 1137 1110

The total batch volume (e. g. 125 ml) and the remaining batch volume still to be dosed are displayed in the 'Operation' menu. During breaks in dosing, the time until the next dosing process (e. g. 1:21) is displayed.

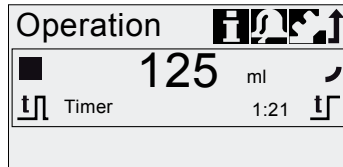

Fig. 27 Dos. Timer Cycle mode

TM04 1136 1110

6.4.6 Dosing timer, week

In this operation mode, up to 16 dosing procedures are defined for a week. These dosing procedures may take place regularly on one or several week days. The setting range for the batch volume corresponds to the values in section 6.4.4 *Batch (pulse-based)*.

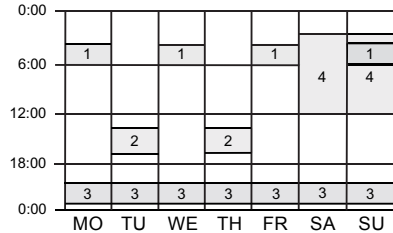

Fig. 28 Week timer dosing

TM04 1108 1109

Note If several procedures overlap, the process with the higher dosing flow has priority!

In the event of an interruption (e. g. disconnection of the mains voltage, external stop), the dosing is stopped while the time continues running. After suspending the interruption, the pump continues to dose according to the actual timeline position.

The following settings are required in the 'Setup > Dos. Timer Week' menu for each dosing procedure:

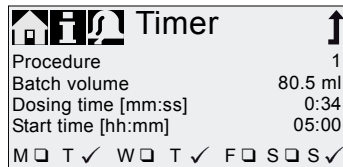

Fig. 29 Setting the timer

TM04 1138 1110

The batch volume (e. g. 80.5 ml) is set in the 'Setup > Dos. Timer Week' menu. The minimum dosing time required for this (e. g. 0:34) is displayed and can be increased.

In the Operation mode, the total batch volume (e. g. 80.5 ml) and the remaining batch volume to be dosed is displayed. During breaks in dosing, the time (e. g. 43:32) until the next dosing is displayed.

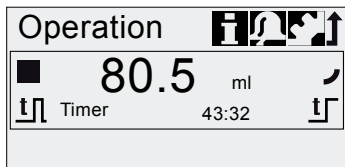

Fig. 30 Weekly timer dosing/break in dosing

TM04 1136 1110

6.5 Analog output

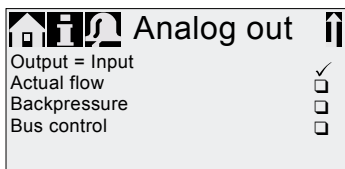

Fig. 31 Configure analog output

TM04 1153 1110

The analog output of the pump is parametrised in the 'Setup > Analog output' menu. The following settings are possible:

Setting	Description Analog output signal	Control variant		
		FCM	FC	AR
Output =input	The analog input signal is mapped 1:1 to the analog output (e. g. to control several pumps using one signal)	X	X	X
Actual flow	Current actual flow • 0/4 mA = 0 % • 20 mA = 100 % see section 6.8.2 Calibration of pressure sensor	X	X*	X*
Backpressure	Backpressure, measured in the dosing head • 0/4 mA = 0 % • 20 mA = 100 % see section 6.8 Pressure monitoring	X	X	
Bus control	Enabled by command in Bus control, see section 6.15 Bus communication	X	X	X

* Output signal is based on motor speed and pump status (target flow).

Wiring diagram see section 4.3 Electrical connection.

Note

In all modes, the analog output has a range of 4-20 mA. Exception: Operation mode 0-20 mA. Here, the analog output range is 0-20 mA.

6.6 SlowMode



When the 'SlowMode' function is enabled, the pump slows down the suction stroke. The function is enabled in the 'Setup > SlowMode' menu and is used to prevent cavitation in the following cases:

- for dosing media with a high viscosity
- for degassing dosing media
- for long suction lines
- for large suction lift.

In the 'Setup > SlowMode' menu, the speed of the suction stroke can be reduced to 50 % or 25 %.

Caution

Enabling the 'SlowMode' function reduces the maximum dosing flow of the pump to the set percentage value!

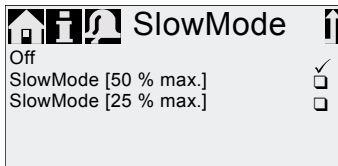

Fig. 32 SlowMode menu

TM04 1153 1110

6.7 FlowControl



FC/FCM control variant.

This function is used to monitor the dosing process. Although the pump is running, various influences e. g. air bubbles, can cause a reduced flow or even stop the dosing process. In order to guarantee optimum process safety, the enabled FlowControl function directly detects and indicates the following errors and deviations:

- Overpressure
- Damaged discharge line
- Air in the dosing chamber
- Cavitation
- Suction valve leakage
- Discharge valve leakage.

The occurrence of a fault is indicated by the 'eye' symbol flashing. The faults are displayed in the 'Alarm' menu (see section 8. *Faults*).

FlowControl works with a maintenance-free sensor in the dosing head. During the dosing process, the sensor measures the current pressure and continuously sends the measured value to the microprocessor in the pump. An internal indicator diagram is created from the current measured values and the current diaphragm position (stroke length). Causes for deviations can be identified immediately by aligning the current indicator diagram with a calculated optimum indicator diagram. Air bubbles in the dosing head reduce e. g. the discharge phase and consequently the stroke volume (see fig. 33).

Setting FlowControl

The 'FlowControl' function is set using the two parameters 'Sensitivity' and 'Delay' in the 'Setup > FlowControl' menu.

Sensitivity

In 'Sensitivity' the deviation in stroke volume, which will result in an error message, is set in percent.

Sensitivity	Deviation
Low	approx. 70 %
Medium	approx. 50 %
High	approx. 30 %

Delay

The 'Delay' parameter is used to define the time period until an error message is generated: 'short', 'medium' or 'long'. The delay depends on the set dosing flow and therefore cannot be measured in strokes or time.

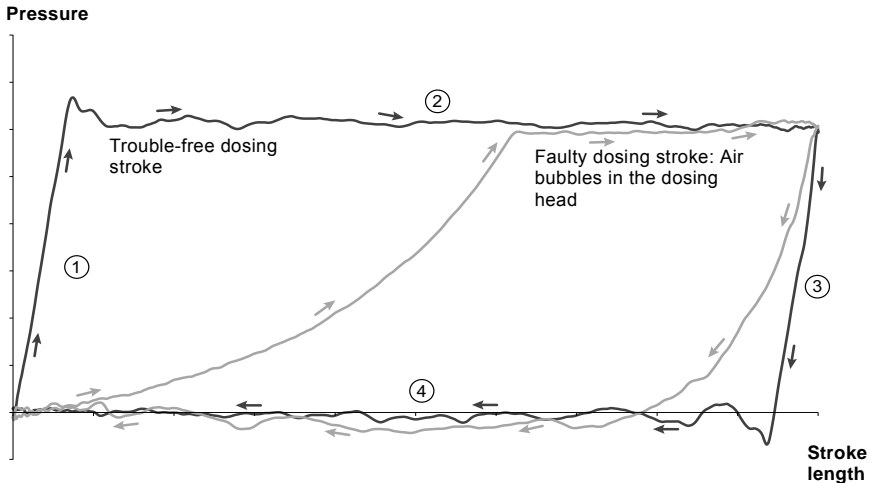

Fig. 33 Indicator diagram

1	Compression phase
2	Discharge phase
3	Expansion phase
4	Suction phase

6.8 Pressure monitoring



FC/FCM control variant.

A pressure sensor monitors the pressure in the dosing head. If the pressure during the discharge phase falls below 2 bar, a warning is generated (pump continues running). If in the 'Setup > Pressure monitoring' menu the function 'Min. pressure alarm' is activated, an alarm is generated and the pump is stopped.

If the pressure exceeds the cut-off pressure set in the 'Setup > Pressure monitoring' menu, the pump is shut down, enters the standby state and indicates an alarm.

Caution *The pump restarts automatically once the backpressure falls below the cut-off pressure!*

6.8.1 Pressure setting ranges

Type	Fixed min. pressure (bar)	Settable max. pressure [bar]
DDA 7.5 - 16	< 2	3 ... 17
DDA 12-10	< 2	3 ... 11
DDA 17-7	< 2	3 ... 8
DDA 30-4	< 2	3 ... 5

The pressure measured in the dosing head is slightly higher than the actual system pressure.

Caution *Therefore the cut-off pressure should be set min. 0.5 bar higher than the system pressure.*



Warning

Install a pressure-relief valve in the pressure line to provide protection against impermissibly high pressure!

6.8.2 Calibration of pressure sensor

The pressure sensor is calibrated in the factory. As a rule, it does not need to be re-calibrated. If specific circumstances (e. g. pressure sensor exchange, extreme air pressure values at the location of the pump) necessitate a calibration, the sensor can be calibrated as follows:

1. Set pump to 'Stop' operational state.
2. Make system pressureless and flush.
3. Dismantle suction line and suction valve.

Calibrating when the suction valve is installed produces incorrect calibration and can cause personal injuries and damage to property!

Caution

Only carry out a calibration if this is technically required!

4. Proceed as described below to calibrate:

Plug in pressure sensor plug or select 'Setup > FlowControl active' menu

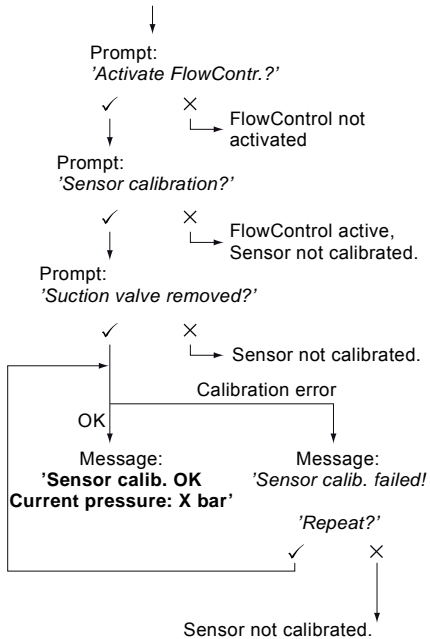

If a calibration is not successfully possible, check plug connections, cable and sensor and replace defective parts where necessary.

TM04 1145 2510

6.9 Flow measurement

FCM control variant

The pump accurately measures the actual flow and displays it. Via the 0/4 - 20 mA analog output, the actual flow signal can easily be integrated into an external process control without additional measuring equipment (see section 6.5 *Analog output*).

The flow measurement is based on the indicator diagram as described in section 6.7 *FlowControl*. The accumulated length of the discharge phase multiplied by the stroke frequency produces the displayed actual flow. Faults e. g. air bubbles or backpressure that is too low result in a smaller or larger actual flow. When the '*AutoFlowAdapt*' function is activated (see section 6.10 *AutoFlowAdapt*), the pump compensates for these influences by correction of the stroke frequency.

Strokes which cannot be analysed (partial strokes, pressure differential which is too low) are provisionally calculated based on the setpoint value and displayed.

Note

6.10 AutoFlowAdapt

FCM control variant.

The '*AutoFlowAdapt*' function is activated in the '*Setup*' menu. It detects changes in various parameters and responds accordingly in order to keep the set target flow constant.

Dosing accuracy is increased when '*AutoFlowAdapt*' is activated.

Note

This function processes information from the pressure sensor in the dosing head. Errors detected by the sensor are processed by the software. The pump responds immediately regardless of the operation mode by adjusting the stroke frequency or where necessary compensating for the deviations with a corresponding indicator diagram.

If the target flow cannot be achieved by the adjustments, a warning is issued.

'*AutoFlowAdapt*' operates on the basis of the following functions:

- FlowControl: malfunctions are identified (see section 6.7 *FlowControl*).
- Pressure monitoring: pressure fluctuations are identified (see section 6.8 *Pressure monitoring*).
- Flow measurement: deviations from the target flow are identified (see section 6.8.2 *Calibration of pressure sensor*).

Examples of '*AutoFlowAdapt*'

Pressure fluctuations

The dosing volume decreases as backpressure increases and conversely the dosing volume increases as the backpressure decreases.

The '*AutoFlowAdapt*' function identifies pressure fluctuations and responds by adjusting the stroke frequency. The actual flow is thus maintained at a constant level.

Air bubbles

The '*AutoFlowAdapt*' function identifies air bubbles. The pump responds with a special indicator diagram due to which the air bubbles are removed as a top priority (deaeration).

If the air bubbles have not been eliminated after a maximum of 60 strokes, the pump switches to the '*Air bubble*' warning status and returns to the normal indicator diagram.

6.11 Auto deaeration

Dosing degassing media can result in air pockets in the dosing head during breaks in dosing. This can result in no medium being dosed when restarting the pump. The '*Setup > Auto deaeration*' function performs pump deaeration automatically at regular intervals. Software-controlled diaphragm movements encourage any bubbles to rise and gather at the discharge valve so that they can be removed on the next dosing stroke.

The function works:

- when the pump is not in the '*Stop*' mode
- during breaks in dosing (e. g. External stop, no incoming pulses, etc.).

Low volumes can be displaced into the discharge line by the diaphragm movements. When dosing strongly degassing media, this is however virtually impossible.

Note

6.12 Key lock



The key lock is set in the 'Setup > Key lock' menu by entering a four-digit code. It protects the pump by preventing changes to settings. Two levels of key lock can be selected:

Level	Description
Settings	All settings can only be changed by entering the lock code. The start/stop key and the 100 % key are not locked.
Settings + keys	The start/stop key and the 100 % key and all settings are locked.

It is still possible to navigate in the 'Alarm' and 'Info' main menu and reset alarms.

Temporary deactivation

If the key lock function is activated but settings need to be modified, the keys can be unlocked temporarily by entering the deactivation code. If the code is not entered within 10 seconds, the display automatically switches to the 'Operation' main menu. The key lock remains active.

Deactivation

The key lock can be deactivated in the 'Setup > Key lock' menu via the 'Off' menu point. The key lock is deactivated after the general code '2583' or a pre-defined custom code has been entered.

6.13 Display Setup

Use the following settings in the 'Setup > Display' menu to adjust the display properties:

- Units (metric/US)
- Display contrast
- Additional display.

6.13.1 Units

Metric units (litres/millilitres/bar) or US units (US gallons/PSI) can be selected. According to the operation mode and menu, the following units of measurement are displayed:

Operation mode/ function	Metric units	US units
Manual control	ml/h or l/h	gph
Pulse control	ml/□	ml/□
0/4-20 mA Analogue control	ml/h or l/h	gph
Batch (pulse- or timer- controlled)	ml or l	gal
Calibration	ml	ml
Volume counter	l	gal
Pressure monitoring	bar	psi

6.13.2 Additional display

Additional display provides additional information about the current pump status. The value is shown in the display with the corresponding symbol.

In 'Manual' mode the 'Actual flow' information can be displayed with Q = 1.28 l/h (see fig. 34).

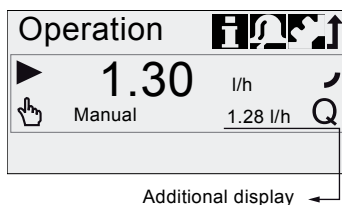

TM04 1151 1110

Fig. 34 Display with additional display

The additional display can be set as follows:

Setting	Description
	<i>Depending on the operation mode:</i>
	Q Actual flow (manual, pulse) ¹⁾
	Q Target flow (pulse)
Default display	↻ Input current (analog)
	Ⓜ Remaining batch volume (Batch, Dos. Timer)
	⏱ Period until next dosing (Dos. Timer)
Dosed volume	V Dosed vol. since last reset (see <i>Counters</i> on page 21)
Actual flow	Q Current actual flow ¹⁾
Backpressure	P Current backpressure in the dosing head ²⁾

¹⁾ only DDA-FCM control variant

²⁾ only DDA-FCM/FC control variant.

6.14 Time/date

The time and date can be set in the 'Setup > Time+date' menu.

Caution

The conversion between summer and winter time does not take place automatically!

6.15 Bus communication

BUS

The pump is supplied with an integrated module for GENbus communication. The pump identifies the bus control after connecting to the corresponding signal input. The "Activate Genibus?" prompt is displayed. After confirmation, the 'Bus' submenu appears in the 'Setup' menu.



Fig. 35 'Setup > Bus' menu

TM04 1139 2410

The corresponding symbol appears in the 'Activated functions' area in the 'Operation' menu.

The pump can also be integrated into a Profibus DP network using the additional E-box module (retrofitting possible).

The bus communication enables remote monitoring and setting of the pump via a fieldbus system. The accompanying fieldbus documentation and the Profibus GSD file can be downloaded from the Internet.

www.grundfosalldos.com

6.16 Inputs/outputs

In the 'Setup > Inputs/outputs' menu, you can configure the two outputs 'Relay 1+2' and the signal inputs 'External stop', 'Empty signal' and 'Low level signal'.

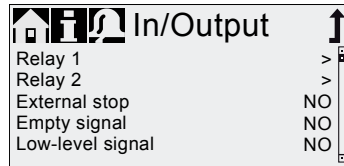

Fig. 36 'Setup > Inputs/outputs' menu

TM04 1152 1110

6.16.1 Relay outputs

The pump can switch two external signals using installed relays. The relays are switched by potential-free pulses. The connection diagram of the relays is shown in section 4.3 *Electrical connection*. Both relays can be allocated with the following signals:

Relay 1 signal	Relay 2 signal	Description
Alarm*	Alarm	Display red, pump stopped (e. g. empty signal, etc.)
Προειδοποίηση*	Warning	Display yellow, pump is running (e. g. low-level signal, etc.)
Stroke signal	Stroke signal*	each full stroke
Pump dosing	Pump dosing	Pump running and dosing
Bus control	Bus control	Activated by a command in the bus communication
	Timer, cycle	see following section
	Timer, week	see following section
Contact type		
NO*	NO*	Normally open contact
NC	NC	Normally closed contact

* Factory setting

Timer, cycle (relay 2)

For the 'Relay 2 > Timer cycle' function, set the following parameters:

- Dosing time (t_1)
- Start delay (t_2)
- Cycle time (t_3)

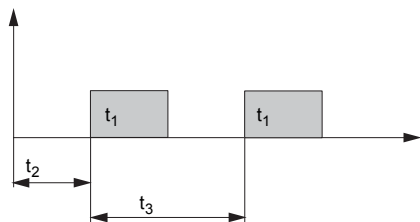

Fig. 37 Diagram

TM04 1124 2110

Timer, week (relay 2)

This function saves up to 16 relay on-times for a week. The following settings can be made for each relay switching operation in the 'Relay 2 > Timer Week' menu:

- Procedure (No.)
- On-time (duration)
- Start time
- Weekdays.

6.16.2 External stop



The pump can be stopped via an external pulse, e. g. from a control room. When activating the external stop pulse, the pump switches from the operational state 'Running' into the operational state 'Standby'. The corresponding symbol appears in the Signal/error display (see section 6.2.2 *Operating states*).

Frequent disengagement from the mains voltage, e. g. via a relay, can result in damage to the pump electronics and to the breakdown of the pump. The dosing accuracy is also reduced as a result of internal start procedures.

Caution

***Do not control the pump via the mains voltage for dosing purposes!
Only use the 'External stop' function to start and stop the pump!***

The contact type is factory-set to closed contact (=>NO). In the 'Setup > Inputs/outputs > External stop' menu, the setting can be changed to open contact (=>NC).

6.16.3 Empty and low-level signals



In order to monitor the filling level in the tank, a dual-level sensor can be connected to the pump. The pump responds to the signals as follows:

Sensor signal	Pump status
Low level	<ul style="list-style-type: none"> • Display is yellow • ▼ flashes • Pump continues running
Empty	<ul style="list-style-type: none"> • Display is red • ▼ flashes • Pump stops

Both signal inputs are allocated to the closed contact (=>NO) in the factory. They can be re-allocated in the 'Setup > Inputs/outputs' menu to open contact (=>NC).

6.17 Basic settings

All settings can be reset to the settings default upon delivery in the 'Setup > Basic settings' menu.

Selecting 'Save customer settings' saves the current configuration to the memory. This can then be activated using 'Load customer settings'.

The memory always contains the previously saved configuration. Older memory data is overwritten.

7. Service

In order to ensure a long service life and dosing accuracy, wearing parts such as diaphragms and valves must be regularly checked for signs of wear. Where necessary, replace worn parts with original spare parts made from suitable materials.

Should you have any questions, please contact your service partner.



Warning

If the diaphragm leaks or is broken, dosing liquid will escape from the discharge opening on the dosing head (see fig. 3).



Take suitable precautions to prevent harm to health and damage to property caused by escaping dosing liquid! Check daily whether liquid is escaping from the discharge opening!

7.1 Service system

According to the motor runtime or after a defined period of operation, service requirements will appear. Service requirements appear regardless of the current operational state of the pump and do not affect the dosing process.

Service requirement	Motor runtime [h]*	Time interval [months]*
'Service soon'	7500	23
'Service now'	8000	24

* Since the last service system reset

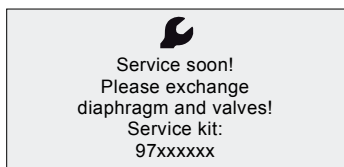

Fig. 38 'Service soon'

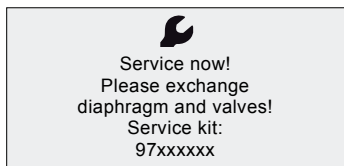



Fig. 39 'Service now'

The service requirement signals when the replacement of wearing parts is due and displays the number of the service kit. Press the click wheel to temporarily hide the service prompt.

When the 'Service now' message appears (displayed daily), the pump must be serviced immediately. To signalise in the 'Operation' menu, the symbol  appears in the 'Signal/error display' area of the display.

The number of the service kit required is also displayed in the 'Info' menu.

For media which result in increased wear, the service interval must be shortened.

7.2 Perform service

Only spare parts and accessories from Grundfos should be used for maintenance. The usage of non-original spare parts and accessories renders any liability for resulting damages null and void.

Information about carrying out maintenance can be found in the service kit catalog on our homepage (www.grundfosalldos.com).

Warning

When dosing dangerous media, observe the corresponding precautions in the safety data sheets!



Risk of chemical burns!

Wear protective clothing (gloves and goggles) when working on the dosing head, connections or lines!

Do not allow any chemicals to leak from the pump. Collect and dispose of all chemicals correctly!

Before any work to the pump, the pump must be in the 'Stop' operational state or be disconnected from the mains. The system must be pressureless!

Caution

TM04 1131 1110

TM04 1131 1110

7.2.1 Dosing head overview

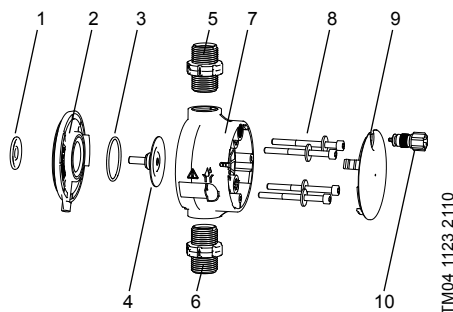





Fig. 40 Changing the diaphragm and valves

1	Safety diaphragm
2	Flange
3	O-ring
4	Diaphragm
5	Valve on discharge side
6	Valve on suction side
7	Dosing head
8	Screws with discs
9	Cover
10	Deaeration valve

7.2.2 Dismantling the diaphragm and valves

1. Make system pressureless.
2. Empty dosing head before maintenance and flush it if necessary.
3. Set pump to 'Stop'  operational state using the 'Start/stop key'.
4. Press the 'Start/stop' and '100 %' keys at the same time to put the diaphragm into 'out' position.
 - Symbol  must be displayed as the operational state (see fig. 14).
5. Take suitable steps to ensure that the returning liquid is safely collected.
6. Dismantle suction, pressure and deaeration hose.
7. Dismantle valves on suction and discharge side (5, 6).
8. Remove the cover (9).
9. Undo screws (8) on the dosing head (7) and remove with discs.
10. Remove the dosing head (7).
11. Unscrew diaphragm (4) counter-clockwise and remove with flange (2).

7.2.3 Reassembling the diaphragm and valves

1. Attach flange (2) correctly and screw on new diaphragm (4) clockwise.
 - Make sure that the O-ring (3) is seated correctly!
2. Press the 'Start/stop' and '100 %' keys at the same time to put the diaphragm into 'in' position.
 - Symbol  must be displayed as the operational state (see fig. 14).
3. Attach the dosing head (7).
4. Install screws with discs (8) and cross-tighten.
 - Torque: 3 Nm.
5. Attach the cover (9).
6. Install new valves (5, 6).
 - Do not interchange valves and pay attention to direction of arrow.
7. Connect suction, pressure and deaeration hose (see section 4.2 *Hydraulic connection*)
8. Press the 'Start/Stop' key to leave the service mode.
9. Deaerate dosing pump (see section 5.2 *Deaerating the pump*).
10. Please observe the notes on commissioning in section 5. *Commissioning*!

7.3 Resetting the service system

After performing the service, the service system must be reset using the 'Info > Reset service system' function.

7.4 Repairs

Warning

The pump housing must only be opened by personnel authorised by Grundfos!



Repairs must only be carried out by authorised and qualified personnel!

Switch off the pump and disconnect it from the voltage supply before carrying out maintenance work and repairs!

After consulting Grundfos, please send the pump, together with the safety declaration completed by a specialist, to Grundfos. The safety declaration can be found at the end of these instructions. It must be copied, completed and attached to the pump.

If the pump has been used to dose toxic liquids or liquids hazardous to health, the pump must be cleaned prior to dispatch!

Caution

If the above requirements are not met, Grundfos may refuse to accept delivery of the pump. The shipping costs will be charged to the sender.

8. Faults



In the event of faults in the dosing pump, a warning or an alarm is triggered. The corresponding fault symbol flashes in the 'Operation' menu, see section 8.1 *List of faults*. The cursor jumps to the 'Alarm' main menu symbol. Press the click wheel to open the 'Alarm' menu and, where necessary, faults to be acknowledged will be acknowledged.

A yellow display indicates a warning and the pump continues running.

A red display indicates an alarm and the pump is stopped.

The last 10 faults are stored in the 'Alarm' main menu. When a new fault occurs, the oldest fault is deleted.

The two most recent faults are shown in the display, you can scroll through all the other faults. The time and cause of the fault are displayed.

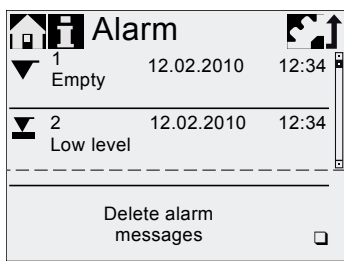





TM04 1109 10 10

The list of faults can be deleted at the end of the list. If there is a service requirement, this appears when the 'Alarm' menu is opened. Press the click wheel to temporarily close the service prompt (see section 7.1 *Service system*).

8.1 List of faults

8.1.1 Faults with error message

Display in the 'Alarm' menu	Possible cause	Possible remedy
▼ Empty (Alarm)	<ul style="list-style-type: none"> Dosing medium tank empty 	<ul style="list-style-type: none"> Fill tank. Check contact setting (NO/NC)
▼ Low level (Warning)	<ul style="list-style-type: none"> Dosing medium tank almost empty 	
Overpressure (Alarm)	<ul style="list-style-type: none"> Discharge valve blocked Isolating valve in discharge line closed Pressure peaks due to high viscosity 'Max. pressure' set too low (see section 6.8 Pressure monitoring) 	<ul style="list-style-type: none"> Replace valve if necessary (see section 7.2 Perform service) Check flow direction of valves (arrow) and correct if necessary. Open the isolating valve (on the discharge side). Enlarge diameter of discharge line. Change pressure setting (see section 6.8 Pressure monitoring).
Backpressure low (Warning/alarm*)	<ul style="list-style-type: none"> Faulty diaphragm Broken discharge line Pressure differential between suction and discharge side too low Leakage in the pressure retention valve at Q < 1 l/h Deaeration valve open 	<ul style="list-style-type: none"> Change the diaphragm (see section 7.2 Perform service). Check discharge line and repair if necessary. Install additional spring-loaded valve (approx. 3 bar) on the discharge side. Close the deaeration valve.
Air bubble (Warning)	<ul style="list-style-type: none"> Broken/leaky suction line Strongly degassing medium Tank dosing medium empty 	<ul style="list-style-type: none"> Check suction line and repair if necessary. Provide positive inlet pressure (place dosing medium tank above the pump). Enable 'Slow Mode' (see section 6.6 SlowMode). Fill tank.
👁 Cavitation (Warning)	<ul style="list-style-type: none"> Blocked/constricted/squeezed suction line Blocked/constricted suction valve Suction lift too high Viscosity too high 	<ul style="list-style-type: none"> Enable 'Slow Mode' (see section 6.6 SlowMode). Reduce suction lift. Increase suction hose diameter. Check suction line and open isolating valve if necessary.
Suct. valve leak (Warning)	<ul style="list-style-type: none"> Leaky/dirty suction valve Deaeration valve open 	<ul style="list-style-type: none"> Check valve and tighten it up. Flush system. Replace valve if necessary (see section 7.2 Perform service). Check O-ring position. Install filter in suction line. Close the deaeration valve.
Disch. valve leak (Warning)	<ul style="list-style-type: none"> Leaky/dirty discharge valve Leakage in the pressure retention valve Deaeration valve open 	<ul style="list-style-type: none"> Check valve and tighten it up. Flush system. Replace valve if necessary (see section 7.2 Perform service). Check O-ring position. Install screen in suction line. Close the deaeration valve. Install spring-loaded valve on the discharge side.
Flow deviation (Warning)	<ul style="list-style-type: none"> Considerable deviation between target and actual flow Pump not / incorrectly calibrated 	<ul style="list-style-type: none"> Check installation. Calibrate the pump (see section 5.3 Calibrating the pump).

Display in the 'Alarm' menu	Possible cause	Possible remedy
 Pressure sensor (Warning)	<ul style="list-style-type: none"> • Broken FlowControl cable • Sensor defect • Pressure sensor not correctly calibrated. 	<ul style="list-style-type: none"> • Check plug connection. • Change sensor if necessary. • Calibrate pressure sensor correctly (see section 6.8.2 <i>Calibration of pressure sensor</i>).
 Motor blocked (alarm)	<ul style="list-style-type: none"> • Backpressure greater than nominal pressure • Damage to gears 	<ul style="list-style-type: none"> • Reduce backpressure. • Arrange for repair of gears, if necessary.
BUS Bus (Warning/alarm*)	<ul style="list-style-type: none"> • Fieldbus communication error 	<ul style="list-style-type: none"> • Check cables for correct specification and damage; replace if necessary. • Check cable routing and shielding; correct if necessary.
 E-Box (Alarm)	<ul style="list-style-type: none"> • E-Box connection error • Faulty E-Box 	<ul style="list-style-type: none"> • Check plug connection. • Replace E-Box if necessary.
 Cable break (Alarm)	<ul style="list-style-type: none"> • Defect in analog cable 4 - 20 mA (input current < 2 mA) 	<ul style="list-style-type: none"> • Check cable/plug connections and replace, if necessary. • Check signal transmitter.
 Service soon/now (Warning)	<ul style="list-style-type: none"> • Time interval for service expired 	<ul style="list-style-type: none"> • Perform service (see section 7.2 <i>Perform service</i>).

* Depending on setting

8.1.2 General faults

Fault	Possible cause	Possible remedy	
Dosing flow too high	Inlet pressure greater than backpressure	Install additional spring-loaded valve (approx. 3 bar) on the discharge side. Increase pressure differential.	
	Incorrect calibration	Calibrate the pump (see section 5.3 <i>Calibrating the pump</i>).	
No dosing flow or dosing flow too low	Air in dosing head	Deaerate the pump.	
	Faulty diaphragm	Change the diaphragm (see section 7.2 <i>Perform service</i>).	
	Leakage/fracture in lines	Check and repair lines.	
	Valves leaking or blocked	Check and clean valves.	
	Valves installed incorrectly	Check that the arrow on the valve housing is pointing in the direction of flow. Check whether all O-rings are installed correctly.	
	Blocked suction line	Clean suction line/install filter. Reduce suction lift.	
	Suction lift too high	Install priming aid. <i>Enable 'Slow Mode'</i> (see section 6.6 <i>SlowMode</i>).	
	Viscosity too high		<i>Enable 'Slow Mode'</i> (see section 6.6 <i>SlowMode</i>).
			Use hose with larger diameter.
			Install spring-loaded valve on the discharge side.
Pump outside the calibration	Calibrate the pump (see section 5.3 <i>Calibrating the pump</i>).		
Deaeration valve open	Close the deaeration valve.		
Irregular dosing	Valves leaking or blocked	Tighten up valves, replace valves if necessary (see section 7.2 <i>Perform service</i>).	
	Backpressure fluctuations	Keep backpressure constant. <i>'AutoFlowAdapt'</i> activate (only FCM).	
Liquid escaping from the discharge opening on the flange	Faulty diaphragm	Change the diaphragm (see section 7.2 <i>Perform service</i>).	
Liquid escaping	Dosing head screws not screwed in as far as they will go	Tighten up screws (see section 4.2 <i>Hydraulic connection</i>).	
	Valves not screwed in as far as they will go	Tighten up valves/union nuts (see section 4.2 <i>Hydraulic connection</i>).	
Pump not sucking in	Suction lift too high	Reduce suction lift; if necessary, provide positive inlet pressure.	
	Backpressure too high	Open the deaeration valve.	
	Soiled valves	Flush system, replace valves if necessary (see section 7.2 <i>Perform service</i>).	

9. Disposal

This product and all its associated parts must be disposed of in an environmentally friendly manner. Use appropriate waste collection services. If there is no such facility or the facility refuses to accept these materials used in the product, the product can be sent to the nearest Grundfos company or Grundfos service centre.



Subject to alterations.

Safety declaration

Please copy, fill in and sign this sheet and attach it to the pump returned for service.

Product type (nameplate) _____

Model number (nameplate) _____

Dosing medium _____

Fault description

Please make a circle around the damaged parts.

In the case of an electrical or functional fault, please mark the cabinet.

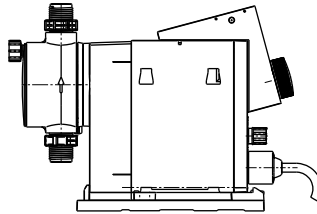
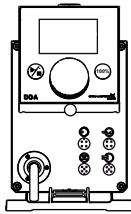

TM04 1185 1110

Please describe the error / cause of the error in brief.

We hereby declare that the pump has been cleaned and is completely free from chemical, biological and radioactive substances.

Date and signature

Company stamp

Argentina

Bombas GRUNDFOS de Argentina S.A.
Ruta Panamericana km. 37.500
Lote 34A
1619 - Garin
Pcia. de Buenos Aires
Phone: +54-3327 414 444
Telefax: +54-3327 411 111

Australia

GRUNDFOS Pumps Pty. Ltd.
P.O. Box 2040
Regency Park
South Australia 5942
Phone: +61-8-8461-4611
Telefax: +61-8-8340 0155

Austria

GRUNDFOS Pumpen Vertrieb Ges.m.b.H.
Grundfosstraße 2
A-5082 Grödig/Salzburg
Tel.: +43-6246-883-0
Telefax: +43-6246-883-30

Belgium

N.V. GRUNDFOS Bellux S.A.
Boomsesteenweg 81-83
B-2630 Aartselaar
Tel.: +32-3-870 7300
Télécopie: +32-3-870 7301

Belorussia

Представительство
ГРУНДФОС в Минске
220123, Минск,
ул. В. Хоружей, 22, оф. 1105
Tel.: +(37517) 233 97 65
Факс: (37517) 233 9769
E-mail:
grundfos_minsk@mail.ru

Bosnia/Herzegovina

GRUNDFOS Sarajevo
Trg Heroja 16,
BiH-71000 Sarajevo
Phone: +387 33 713 290
Telefax: +387 33 659 079
e-mail: grundfos@bih.net.ba

Brazil

BOMBAS GRUNDFOS DO BRASIL
Av. Humberto de Alencar
Castelo Branco, 630
CEP 09850 - 300
São Bernardo do Campo - SP
Phone: +55-11 4393 5533
Telefax: +55-11 4343 5015

Bulgaria

Grundfos Bulgaria EOOD
Slatina District
Iztochna Tangenta street no. 100
BG - 1592 Sofia
Tel. +359 2 49 22 200
Fax. +359 2 49 22 201
email: bulgaria@grundfos.bg

Canada

GRUNDFOS Canada Inc.
2941 Brighton Road
Oakville, Ontario
L6H 6C9
Phone: +1-905 829 9533
Telefax: +1-905 829 9512

China

**Grundfos Aldos
Dosing & Disinfection**
ALLDOS (Shanghai) Water
Technology Co. Ltd.
West Unit, 1 Floor, No. 2
Building (T 4-2)
278 Jinhua Road, Jin Qiao
Export Processing Zone
Pudong New Area
Shanghai, 201206
Phone: +86 21 5055 1012
Telefax: +86 21 5032 0596
E-mail: grundfosaldos-
CN@grundfos.com

China

GRUNDFOS Pumps
(Shanghai) Co. Ltd.
22 Floor, Xin Hua Lian Building
755-775 Huai Hai Rd, (M)
Shanghai 200020
PRC
Phone: +86-512-67 61 11 80
Telefax: +86-512-67 61 81 67

Croatia

GRUNDFOS CROATIA d.o.o.
Cebini 37, Buzin
HR-10010 Zagreb
Phone: +385 1 6595 400
Telefax: +385 1 6595 499
www.grundfos.hr

Czech Republic

GRUNDFOS s.r.o.
Čapkovského 21
779 00 Olomouc
Phone: +420-585-716 111
Telefax: +420-585-716 299

Denmark

GRUNDFOS DK A/S
Martin Bachs Vej 3
DK-8850 Bjerringbro
Tlf.: +45-87 50 50 50
Telefax: +45-87 50 51 51
E-mail:
info_GDK@grundfos.com
www.grundfos.com/DK

Estonia

GRUNDFOS Pumps Eesti OÜ
Peterburi tee 92G
11415 Tallinn
Tel: + 372 606 1690
Fax: + 372 606 1691

Finland

OY GRUNDFOS Pumput AB
Mestarintie 11
FIN-01730 Vantaa
Phone: +358-3066 5650
Telefax: +358-3066 56550

France

Pompes GRUNDFOS
Distribution S.A.
Parc d'Activités de Chesnes
57, rue de Malacombe
F-38290 St. Quentin Fallavier
(Lyon)
Tél.: +33-4 74 82 15 15
Télécopie: +33-4 74 94 10 51

Germany

GRUNDFOS Water Treatment
GmbH
Reetzstraße 85
D-76327 Pfinztal (Söllingen)
Tel.: +49 7240 61-0
Telefax: +49 7240 61-177
E-mail: gwt@grundfos.com

Germany

GRUNDFOS GMBH
Schlüterstr. 33
D-40699 Erkrath
Tel.: +49-(0) 211 929 69-0
Telefax: +49-(0) 211 929 69-
3799
E-mail:
infoservice@grundfos.de
Service in Deutschland:
E-mail:
kundendienst@grundfos.de

Greece

GRUNDFOS Hellas A.E.B.E.
20th km. Athinon-Markopoulou
Av.
P.O. Box 71
GR-19002 Peania
Phone: +0030-210-66 83 400
Telefax: +0030-210-66 46 273

Hong Kong

GRUNDFOS Pumps (Hong
Kong) Ltd.
Unit 1, Ground floor
Siu Wai Industrial Centre
29-33 Wing Hong Street &
68 King Lam Street, Cheung
Sha Wan
Kowloon
Phone: +852-27861706 /
27861741
Telefax: +852-27858664

Hungary

GRUNDFOS Hungária Kft.
Park u. 8
H-2045 Törökbalint,
Phone: +36-23 511 110
Telefax: +36-23 511 111

India

GRUNDFOS Pumps India
Private Limited
118 Old Mahabalipuram Road
Thoraipakkam
Chennai 600 096
Phone: +91-44 2496 6800

Indonesia

PT GRUNDFOS Pompa
Jl. Rawa Sumur III, Blok III /
CC-1
Kawasan Industri, Pulogadung
Jakarta 13930
Phone: +62-21-460 6909
Telefax: +62-21-460 6910 / 460
6901

Ireland

GRUNDFOS (Ireland) Ltd.
Unit A, Merrywell Business
Park
Ballymount Road Lower
Dublin 12
Phone: +353-1-4089 800
Telefax: +353-1-4089 830

Italy

GRUNDFOS Pompe Italia S.r.l.
Via Gran Sasso 4
I-20060 Truccazzano (Milano)
Tel.: +39-02-95838112
Telefax: +39-02-95309290 /
95838461

Japan

GRUNDFOS Pumps K.K.
Gotanda Metalion Bldg. 5F,
5-21-15, Higashi-gotanda
Shiagawa-ku, Tokyo,
141-0022 Japan
Phone: +81 35 448 1391
Telefax: +81 35 448 9619

Korea

GRUNDFOS Pumps Korea Ltd.
6th Floor, Aju Building 679-5
Yeoksam-dong, Kangnam-ku,
135-916
Seoul, Korea
Phone: +82-2-5317 600
Telefax: +82-2-5633 725

Latvia

SIA GRUNDFOS Pumps Latvia
Deglava biznesa centrs
Augusta Deglava ielā 60, LV-
1035, Rīga,
Tālr.: + 371 714 9640, 7 149
641
Fakss: + 371 914 9646

Lithuania

GRUNDFOS Pumps UAB
Smolensko g. 6
LT-03201 Vilnius
Tel: + 370 52 395 430
Fax: + 370 52 395 431

Malaysia

GRUNDFOS Pumps Sdn. Bhd.
7 Jalan Peguam U1/25
Glenmarie Industrial Park
40150 Shah Alam
Selangor
Phone: +60-3-5569 2922
Telefax: +60-3-5569 2866

México

Bombas GRUNDFOS de
México S.A. de C.V.
Boulevard TLC No. 15
Parque Industrial Siva
Aeropuerto
Apodaca, N.L. 66600
Phone: +52-81-8144 4000
Telefax: +52-81-8144 4010

Netherlands

GRUNDFOS Netherlands
Veluwezoom 35
1326 AE Almere
Postbus 22015
1302 CA ALMERE
Tel.: +31-88-478 6336
Telefax: +31-88-478 6332
E-mail: info_gnl@grundfos.com

New Zealand

GRUNDFOS Pumps NZ Ltd.
17 Beatrice Tinsley Crescent
North Harbour Industrial Estate
Albany, Auckland
Phone: +64-9-415 3240
Telefax: +64-9-415 3250

Norway

GRUNDFOS Pumper A/S
Strømsveien 344
Postboks 235, Leirdal
N-1011 Oslo
Tlf.: +47-22 90 47 00
Telefax: +47-22 32 21 50

Poland

GRUNDFOS Pompy Sp. z o.o.
ul. Klonowa 23
Baranowo k. Poznań
PL-62-081 Przemierowo
Tel: (+48-61) 650 13 00
Fax: (+48-61) 650 13 50

Portugal

Bombas GRUNDFOS Portugal,
S.A.
Rua Calvet de Magalhães, 241
Apartado 1079
P-2770-153 Paço de Arcos
Tel.: +351-21-440 76 00
Telefax: +351-21-440 76 90

România

GRUNDFOS Pompe România
SRL
Bd. Biruintei, nr 103
Pantelimon county Ilfov
Phone: +40 21 200 4100
Telefax: +40 21 200 4101
E-mail: romania@grundfos.ro

Russia

ООО Грундфос
Россия, 109544 Москва, ул.
Школьная 39
Тел. (+7) 495 737 30 00, 564
88 00
Факс (+7) 495 737 75 36, 564
88 11
E-mail
grundfos.moscow@grundfos.c
om

Serbia

GRUNDFOS Predstavništvo
Beograd
Dr. Milutina Ivkovića 2a/29
YU-11000 Beograd
Phone: +381 11 26 47 877 / 11
26 47 496
Telefax: +381 11 26 48 340

Singapore

GRUNDFOS (Singapore) Pte.
Ltd.
24 Tuas West Road
Jurong Town
Singapore 638381
Phone: +65-6865 1222
Telefax: +65-6861 8402

Slovenia

GRUNDFOS d.o.o.
Šlandrova 8b, SI-1231
Ljubljana-Crnuče
Phone: +386 1 568 0610
Telefax: +386 1 568 0619
E-mail: slovenia@grundfos.si

South Africa

Grundfos (PTY) Ltd.
Corner Mountjoy and George
Allen Roads
Wilbart Ext. 2
Bedfordview 2008
Phone: (+27) 11 579 4800
Fax: (+27) 11 455 6066
E-mail: lsmart@grundfos.com

Spain

Bombas GRUNDFOS España
S.A.
Camino de la Fuentecilla, s/n
E-28110 Algete (Madrid)
Tel.: +34-91-848 8800
Telefax: +34-91-628 0465

Sweden

GRUNDFOS AB
(Box 333) Lunnagårdsgatan 6
431 24 Mölndal
Tel.: +46(0)771-32 23 00
Telefax: +46(0)31-331 94 60

Switzerland

GRUNDFOS ALLDOS
International AG
Schönmattdstraße 4
CH-4153 Reinach
Tel.: +41-61-717 5555
Telefax: +41-61-717 5500
E-mail: grundfosalldos-
CH@grundfos.com

Switzerland

GRUNDFOS Pumpen AG
Bruggacherstrasse 10
CH-8117 Fällanden/ZH
Tel.: +41-1-806 8111
Telefax: +41-1-806 8115

Taiwan

GRUNDFOS Pumps (Taiwan)
Ltd.
7 Floor, 219 Min-Chuan Road
Taichung, Taiwan, R.O.C.
Phone: +886-4-2305 0868
Telefax: +886-4-2305 0878

Thailand

GRUNDFOS (Thailand) Ltd.
92 Chaloe Phrakiat Rama 9
Road,
Dokmai, Pravej, Bangkok
10250
Phone: +66-2-725 8999
Telefax: +66-2-725 8998

Turkey

GRUNDFOS POMPA San. ve
Tic. Ltd. Sti.
Gebze Organize Sanayi Bölgesi
Ihsan dede Caddesi,
2. yol 200. Sokak No. 204
41490 Gebze/ Kocaeli
Phone: +90 - 262-679 7979
Telefax: +90 - 262-679 7905
E-mail: satis@grundfos.com

Ukraine

ТОВ ГРУНДФОС УКРАЇНА
01010 Київ, Вул. Московська
8б,
Тел.: (+38 044) 390 40 50
Факс.: (+38 044) 390 40 59
E-mail: ukraine@grundfos.com

United Arab Emirates

GRUNDFOS Gulf Distribution
P.O. Box 16768
Jebel Ali Free Zone
Dubai
Phone: +971-4- 8815 166
Telefax: +971-4-8815 136

United Kingdom

GRUNDFOS Pumps Ltd.
Grovebury Road
Leighton Buzzard/Beds. LU7
8TL
Phone: +44-1525-850000
Telefax: +44-1525-850011

U.S.A.

GRUNDFOS Pumps
Corporation
17100 West 118th Terrace
Olathe, Kansas 66061
Phone: +1-913-227-3400
Telefax: +1-913-227-3500

15.720310 V1.0

95724708 1110

GB

ECM: 1065172

The name Grundfos, the Grundfos logo, and the payoff Be-Think-Innovate are registered trademarks owned by Grundfos Management A/S or Grundfos A/S, Denmark. All rights reserved worldwide.
